



# COMUNE DI STRIANO

AREA METROPOLITANA DI NAPOLI

PROGETTO ESECUTIVO



COMPLETAMENTO PALESTRA SCUOLA MEDIA "A. D'AVINO"

TAVOLA	PROGETTO	SCALA
5	ABACO INFISSI ESTERNI	1:25

Il Progettista

IL SINDACO  
Arch. Aristide Rendina

IL R.U.P.  
Arch. Vittorio Celentano

DATA: Giugno 2018

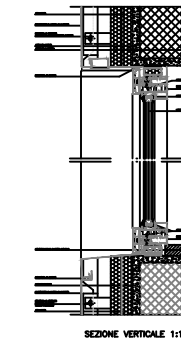

Tipo Infisso	Dimensioni	Materiale	Quantità
Finestra apertura Scorrevole	570x60	Alluminio R40	n. 1

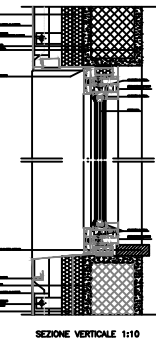

Tipo Infisso	Dimensioni	Materiale	Quantità
Finestra apertura Scorrevole	230x60	Alluminio R40	n. 1

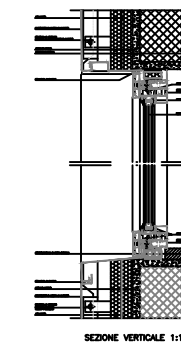
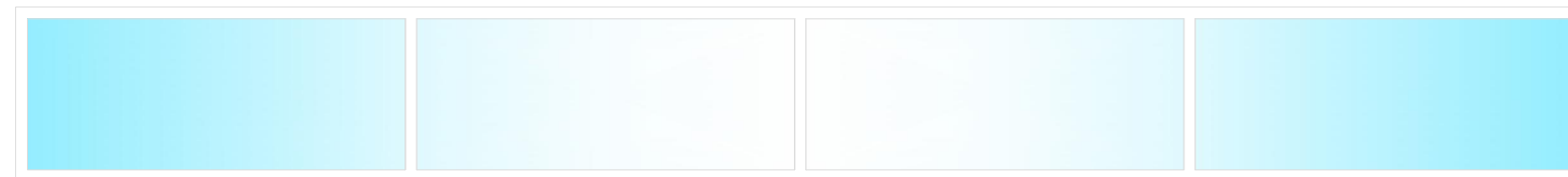

Tipo Infisso	Dimensioni	Materiale	Quantità
Finestra apertura Scorrevole	540x60	Alluminio R40	n. 3

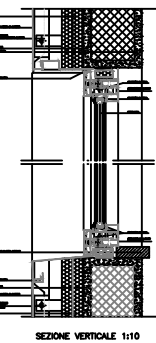

Tipo Infisso	Dimensioni	Materiale	Quantità
Finestra apertura Scorrevole	460x60	Alluminio R40	n. 1

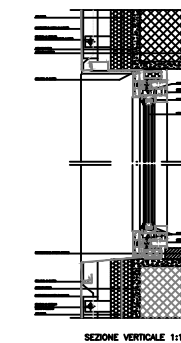

Tipo Infisso	Dimensioni	Materiale	Quantità
Finestra apertura Scorrevole	480x60	Alluminio R40	n. 2

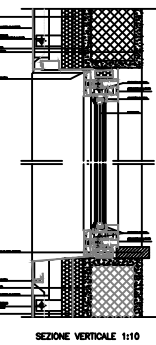

Tipo Infisso	Dimensioni	Materiale	Quantità
Finestra apertura Scorrevole	570x60	Alluminio R40	n. 1

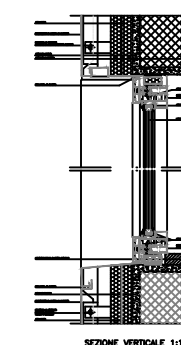

Tipo Infisso	Dimensioni	Materiale	Quantità
Finestra apertura Scorrevole	208x60	Alluminio R40	n. 2

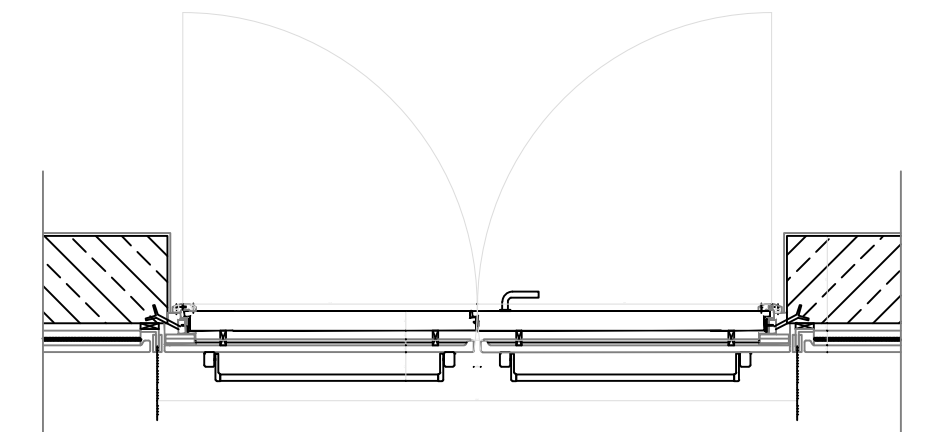
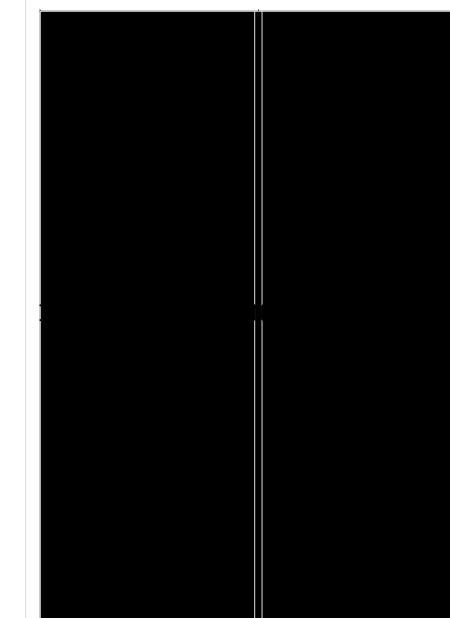

Tipo Infisso	Dimensioni	Materiale	Quantità
Porta Antipanico	150x210		n. 1